

**Nokeval**

No 150699

# Operators Manual 538-5



***Nokeval Oy***

Yrittäjätatu 12  
FIN-37100 NOKIA  
FINLAND

Tel. +358 3-342 4800  
Fax. +358 3-342 2066

## Multipoint indicator 538-5

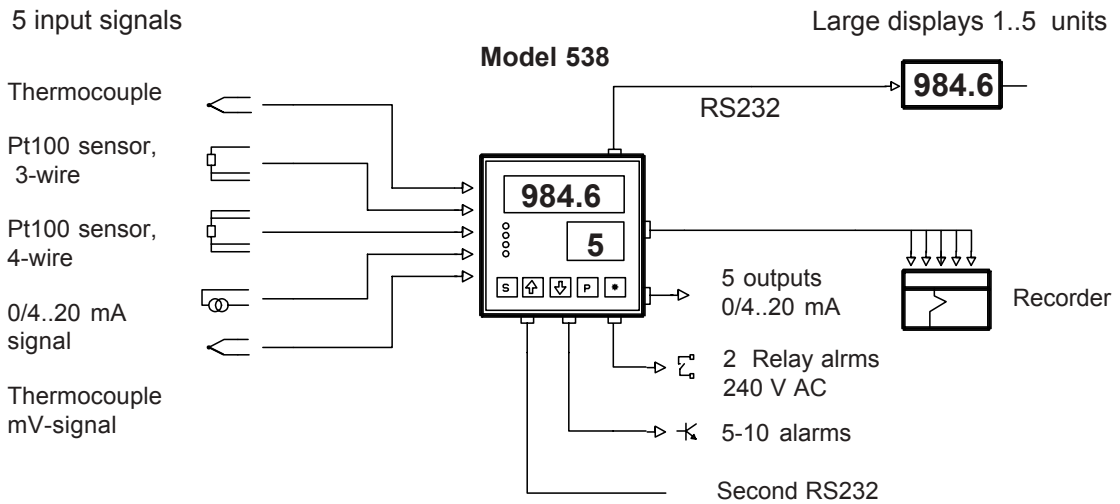

Different types of input signals can be connected to any channel at the same time.

## General description

The Nokeval multipoint indicator 538 is designed for applications, where display, output signals and alarms are desired for several measurements simultaneously. Each input channel can be individually configured for various input signals. For example, the first channel may accept thermocouple input, the second one Pt100, the third channel 4-20 mA, and so forth. Mathematical functions, such as addition, subtraction, multiplication or division, can be made between the channels.

The 538 provides 7 alarms, 2 relay alarms as standard and 7 logic alarms on an extra card. They may all set to one channel, or according to any other option.

The settings can be affected either via front panel or though a PC. The built in serial port RS232 allows communication with computers, printers, PLC's, dataloggers or large displays.

The number of inputs and outputs can be increased by adding supplementary field modules. Designed for performance and reliability, the 538, once configured, is easy to install and quick to operate. The automatic decimal point placement expands the

display by showing the small values with decimal point throughout the 0..9999 display of the meter. This function is enabled by the 16 bit A/D converter, with a resolution of 1/64000.

The autocalibration takes place once a second, which eliminates temperature drifts and long term changes of the zero level and the measuring range. No potentiometers are used for adjustments.

The modular design and the remarkable, inbuilt flexibility enables the 538 to be programmed for variety of different tasks. It can be customized with software that meets the particular and individual needs of each specific application.

Serial communications allow the 538 to be integrated into a larger system, with capability of driving expansion I/O modules. In addition, several instruments can be connected in a network. As the 538 is also capable of implementing math calculation between any channel, you will no longer need separate units for various applications. This kind of versatility can not normally be found in low-cost instrumentation.

## SPECIFICATIONS

### Pt100 sensor

Range 200...+700 °C. Resolution 0,1 or 1 °C. Accuracy 0,1 % ±1 digit in 4 wire connection and 0,2°C ± 1 digit in 3-wire connection.

The max. difference between channels 0,1 °C.

### Thermocouples

K, J, J/DIN, T, E, R and S  
Accuracy 1 °C ± 1 digit. Types R,S 2 C ± 1 digit. Sensor wires have no effect below 1000 Ω.

### Input 0/4...20 mA

Scalable range -999...+9999.  
Automatic decimal point placement. Input resistance 15 Ω.  
Accuracy 0.02% of range.

### Voltage inputs

Range -300...+300.0 mV  
Resolution 0.01 in range 0..99,99 mV. Floating decimal point selects the max. accuracy of display in other ranges. Accuracy 0.02% of range

### Output 0/4..20 mA

The zero point and range is scaleable over the whole display range.

Each channel has its own range Settings on the front panel. Accuracy 0,05% of the display range +accuracy of input signal.  
Channel updating rate 0,1s. Optional galvanic isolation between input and output.

### Alarms

Alarms selectable to any channel or all to one channel or one common relay alarm for all channels.

Adjustable hysteresis.

2 inbuilt alarm relays, 230 VAC, 3 A. Also available 5 logic alarms (open collector) on separate card. Logic alarms can not be used simultaneously with second RS output.

### Serial output

One inbuilt RS232 output and the second RS232 on separate card. Protocol: 8 data bit, 1 stop

bit, no parity, 300 baud. The second output can not be used simultaneously with logic alarms.

### General features

4-digit, red LED display.  
Digit height 14,5 mm.  
Keybad on front panel.  
Settings via front panel or PC.  
Case dimensions 96•96•162 mm.  
Panel cut out 91•91 mm.  
Removable connectors, 1,5 mm<sup>2</sup>.  
Line voltage 230 V/110 VAC, 50/60 HZ  
Weigth 1,5 kg.

## Connections:

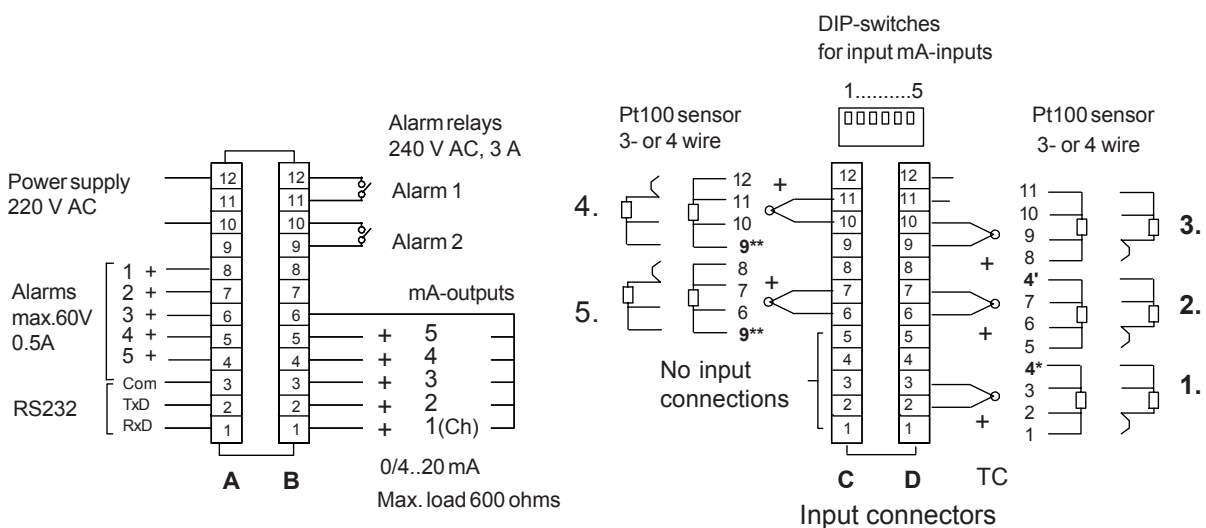

### Note !

0/4..20 mA inputs: as thermocouple inputs.  
Dip-switches 1..5 (Ch1..Ch5) = ON-positions  
Input resistance 50 ohms

### Note:

\* Number 4 is same for channel 1 and 2  
\*\* Number 9 is same for channel 4 and 5

# Front panel:

LED lamps in the front panel indicates:

- Stop scanning (CH)
- Alarm 1
- Alarm 2
- Set point of alarms or configuration

S-key stops scanning of channels or indicates alarm setpoint. You can only see alarm value, but not change it by this key.

Arrow keys to change setting values and channel selection.

### Alarm Checking:

Stop automatic scanning with S-key, light Ch lits. Select the desired channel with arrow-keys. If you push S-key once, **Alarm 1** light lits, push it twice and **Alarm 2** light lits. **Conf** indicator informs that the display shows alarm value. You can exit this mode by pushing \*-key.

### Alarm setting:

When automatic scanning is stopped **Alarm 1** or **Alarm 2** and **Conf** indicators lits, alarm value can be changed. Select the desired channel by arrow-keys, push **P**-key. Decimal point of channel display indicates that you can change alarm values by arrow keys. When new setpoint is selceted push \*-key twice. Unit is now in normal mode.

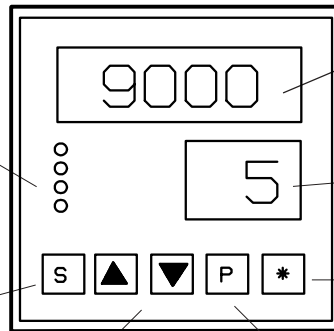

Measured value,  $\pm 9999$ . Floating Decimal point.

Channel number in display

1. Enter-key accepts changing of settings.
2. Return to automatic scanning

### Acces to programming mode:

Hold P-key and push S-key at the same time. Display shows text **Conf**.

### Exit configuration:

When display shows text **Conf**, push P-key, text **donE** appears to display for 2 seconds.

### Manual reset for alarms:

Stop automatic scanning to desired channel, push P-key, alarm is now resetted. Resetting is individual for each channel.

### Eeprom reset:

Programmed information is stored in Eeprom memory. When starting new configuration it is recomend to reset the old information. Hold down S-key and connect the main power. Unit is now in common setup and texts **Conf** and **CO** are in display.

This procedure can also be used, if it seems that the unit doesn't work properly. After reset all configurations must be done again.

## Dimensions

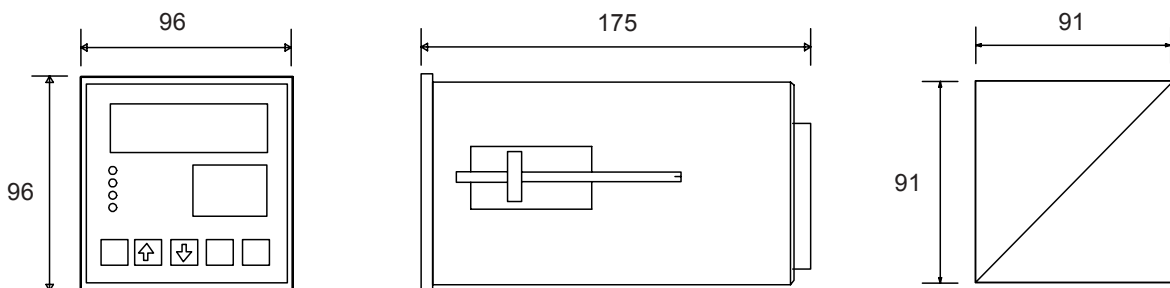



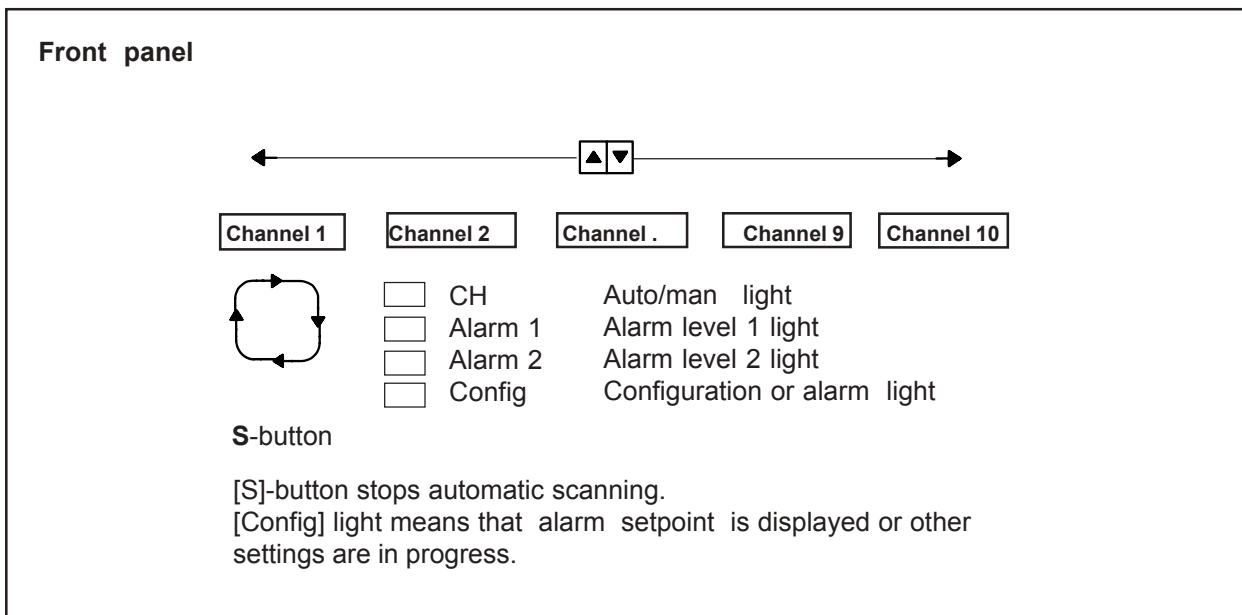

Panel cut-out 91 x 91 mm



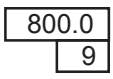

# Front panel



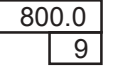

## Selection of channel

Display	Buttons	Description
		Automatic scanning of channels
		By this button you can stop scanning
		Change channel by up-down buttons
		Return to automatic scanning

## Alarm settings



		Automatic scanning of channels
		Stop channel
		Select channel
		Select alarm 1 or 2

## Setpoint changing

	Press [P] Decimal point of the channel starts to light.
	Select alarm value by up-down buttons.
	Push button once, you can select new channel. Push it twice and unit is in automatic scanning.





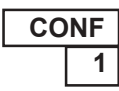









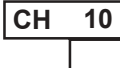



# Programming from the front panel

## Common settings

Display	Buttons
	 + 
	Press [P] and then [S] at the same time until the screen displays [CONF]
	CONF means that you are ready to start programming.

## Common settings

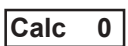
You can select the number of input/output channels used, or special functions between channels etc.

 	 	Select text CO to the channel screen by up-down buttons.
	 	Select total number of input channels (1..5)
	 	External channels for mathematical functions, E1..E5.
	 	Select number of alarms (0...7, standard 1-2, optional 3-7)
	 	Select number of outputs (0...5)
 	 	Special settings. (Factory use only).

## Channel settings

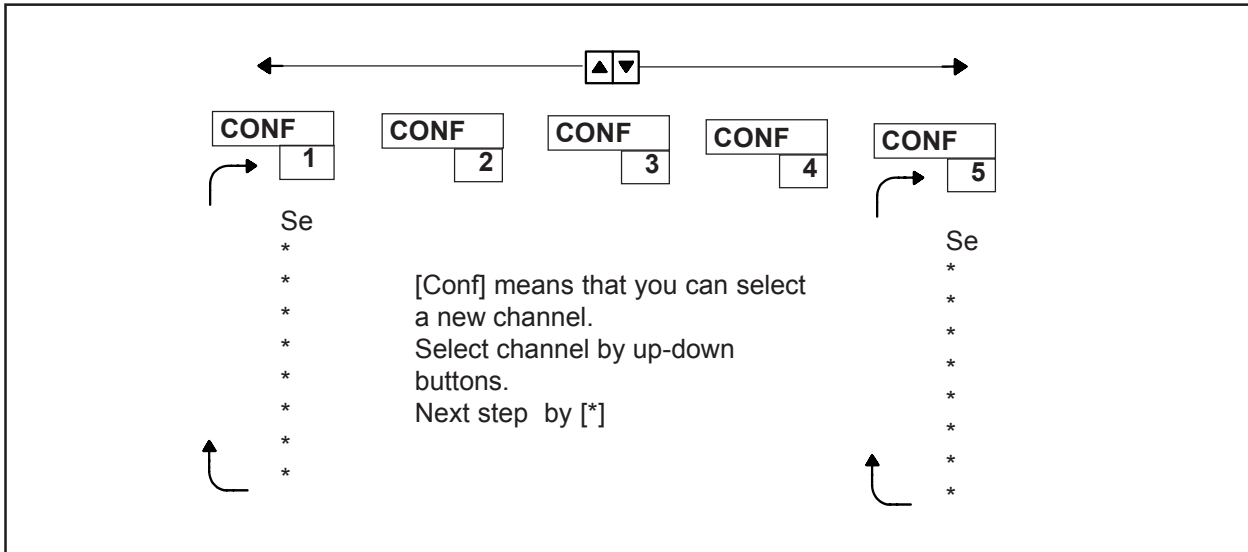

### Select channel number and press [\*]

- |        |    |   |  |
|--------|----|---|--|
| CONFIG | 1  | * | Select channel by up-down buttons.   |
| SE     | 1  | * | Select type of input signal<br>0: None                      7: TC J/DIN                      14: $\sqrt{4..20}$ mA<br>1: 0..20 mA                  8: TC K                            15: Ni100 3-wire<br>2: 4..20mA                   9: TC R                            16: Ni100 4-wire<br>3: Pt100 3-wire              10: TC S<br>4: Pt100 4-wire              11: TC T<br>5: TC E                        12: mV<br>6: TC J                         13: $\sqrt{0..20}$ mA |
| En     | 1  | * | Select whether channel is dilayed or not, in automatic scannig.<br>1 = Channel displayed, 0 = Not displayed.   |
| Ed     | 1  | * | External display (via RS232) 1=external display , 0=none   |
| DE     | 1  | * | Select decimals, 0...3. Floating decimal point.  |
| Lo     | 00 | * | Select low-end of display, f.ex 0.0 (= 0 or 4 mA input).   |
| Hi     | 00 | * | Select high-end of display f.ex 100.0 (= 20 mA input)<br>(only if sensor SE=1 or 2 is selected).   |
| Loff   |    | * | Offset changing, f.ex. -1.0 degrees below measured value<br>Press *-key and set value.   |



## Output Scaling

OC 1	* — ▲▼ ↓	Select type of output. 0=none, 1=0..20 mA, 2= 4..20 mA.
OL 0	* — ▲▼ ↓	Select output line, 1..5. 0=no outputs.
LO 1	* — ▲▼ ↓	Select zero level for output ( display= 4 mA output)
Hi	* — ▲▼ ↓	Select max. value ( display= 20 mA output)

### Alarms

AC	* — ▲▼ ↓	Select alarm type <b>(Alarm 1)</b>
		0: None
		1: Low alarm            On-off alarm
		2: High alarm           On-off alarm
		3: Low alarm            Manual reset
		4: High alarm            Manual reset

AL	* — ▲▼ ↓	Select alarm relay. Relays 1..2 as a standard, 3..7 optional.
ALAR	* — ▲▼ ↓	Alarm setpoint value. You can set alarm level now or later.
HYS	* — ▲▼ ↓	Select hysteresis 0...100 %.

AC	* — ▲▼ ↓	Select alarm type <b>(Alarm 2)</b>
		0: None
		1: Low alarm            On-off alarm
		2: High alarm           On-off alarm
		3: Low alarm            Manual reset
		4: High alarm            Manual reset

AL	* — ▲▼ ↓	Select alarm relay. Relays 1..2 as a standard, 3..7 optional.
ALAR	* — ▲▼ ↓	Alarm setpoint value. You can set alarm level now or later.
HYS	* — ▲▼ ↓	Select hysteresis 0...100 %.

CONF

Pres \*-key to exit configuration or select new channel by arrow keys.

## End of configuration

CONF	P	<b>Save and exit</b>
DONE		Display will show the text <b>done</b> a few seconds after exit.
<b>If you are not sure that settings are correct, you can store old settings by [S] and exit.</b>		
LOAD	S	Exit without saving new values. Earlier settings are stored. Display will show the text <b>load</b> .
After text <b>DONE</b> , normal measuring continues.		

## Definition of mathematical functions for third channel

The display may show 5..10 channels (extended channels E1..E5 i.e. the result of the calculations between channels. The E1...E5 channels operate exactly like the physical channels and may have alarms or output signal. Automatic scanning can show channels 1..5 and E1..E5, or may not be shown, if desired. However, you can look at all channels by bush buttons on instrument front or freeze the display on any time.

### Definition of functions to channels E1...E5

Choose channel to display by arrow buttons and press \*-button.

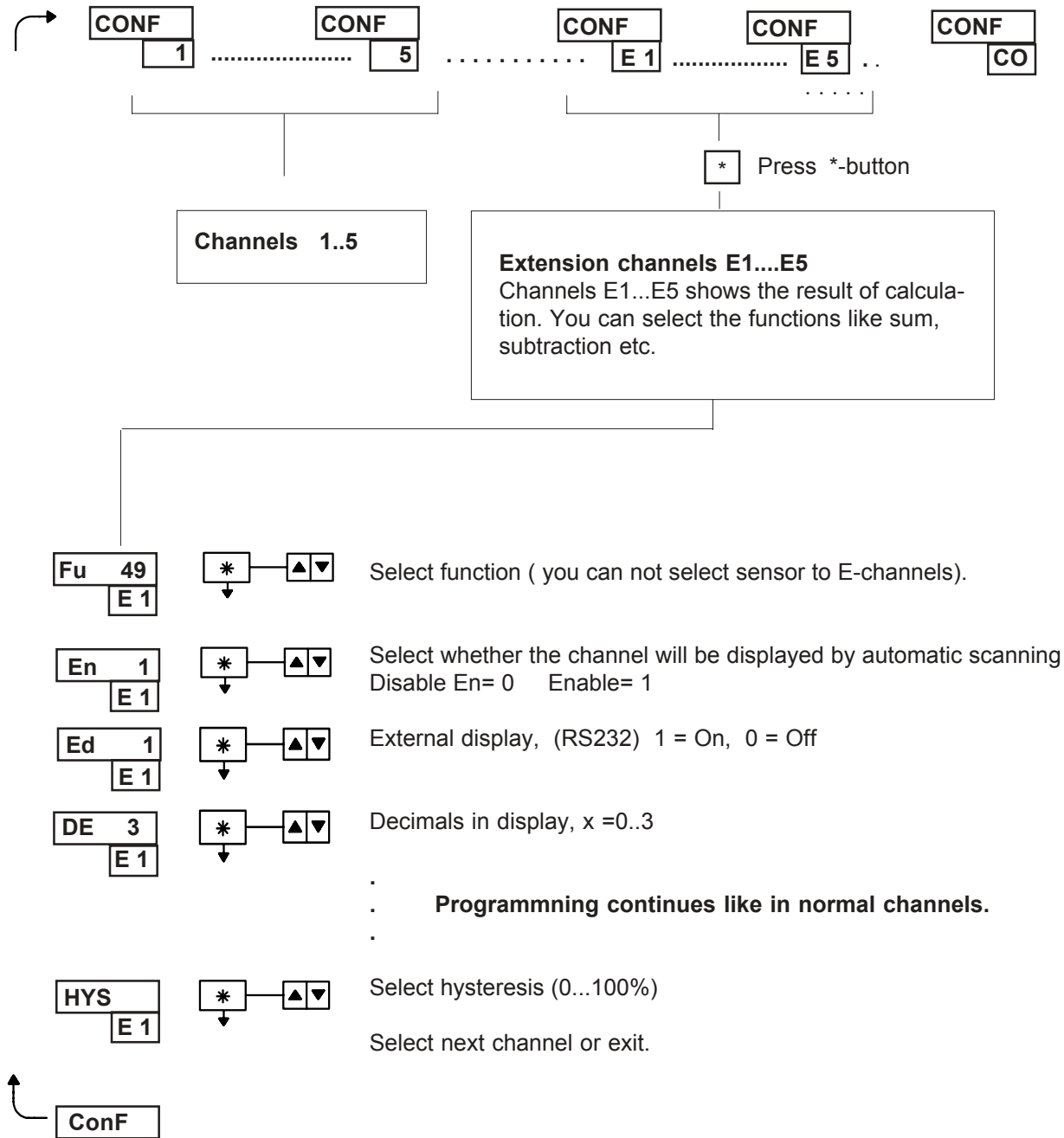

You can set alarms, outputs to channels E1..E5 and use them as input to channels 1...5.

**Mathematical functions (Ch1...Ch5 and E1..E5):**

No	Functions	No	Functions
1	$\sqrt{C1}$ (Channel 1)		
2	$\sqrt{C2}$ (Channel 2)		
3	$\sqrt{C3}$ (Channel 3)		
4	$\sqrt{C4}$ (Channel 4)		
5	$\sqrt{C5}$ (Channel 5)		
6	$C1^2$ (Channel 1)		
7	$C2^2$ (Channel 2)		
8	$C3^2$ (Channel 3)		
9	$C4^2$ (Channel 4)		
10	$C5^2$ (Channel 5)		
11	log C1 (Channel 1)		
12	log C2 (Channel 2)		
13	log C3 (Channel 3)		
14	log C4 (Channel 4)		
15	log C5 (Channel 5)		
16	In C1 (Channel 1)		
17	In C2 (Channel 2)		
18	In C3 (Channel 3)		
19	In C4 (Channel 4)		
20	In C5 (Channel 5)		
21	$10^{C1}$ (Channel 1)		
22	$10^{C2}$ (Channel 2)		
23	$10^{C3}$ (Channel 3)		
24	$10^{C4}$ (Channel 4)		
25	$10^{C5}$ (Channel 5)		
26	$e^{C1}$ (Channel 1)		
27	$e^{C2}$ (Channel 2)		
28	$e^{C3}$ (Channel 3)		
29	$e^{C4}$ (Channel 4)		
30	$e^{C5}$ (Channel 5)		
31	(Channel 1) - (Channel 2)		
32	(Channel 3) - (Channel 4)		
33	(Channel 1) - (Channel 3)		
34	(Channel 1) + (Channel 2)		
35	(Channel 3) + (Channel 4)		
36	(Channel 1) + (Channel 3)		
37	(Channel 1) • (Channel 2)		
38	(Channel 3) • (Channel 4)		
39	(Channel 1) • (Channel 3)		
40	(Channel 1) / (Channel 2)		
41	(Channel 3) / (Channel 4)		
42	(Channel 1) / (Channel 3)		
43	(Channel 1) / (Channel 2) %		
44	(Channel 3) / (Channel 4) %		
45	(Channel 1) / (Channel 3) %		
46	Average value (Channels: 1, 2)		
47	Average value (Channels: 1, 2, 3)		
48	Average value (Channels: 1,2,3,4)		
49	Average value (Channels: 1,2,3,4,5)		
50	Avg (measuring rates 3) (Channel 1)		
51	Avg (measuring rates 3) (Channel 2)		
52	Avg (measuring rates 3) (Channel 3)		
53	Avg (measuring rates 3) (Channel 4)		
54	Avg (measuring rates 3) (Channel 5)		
55	Avg (measuring rates 5) (Channel 1)		
56	Avg (measuring rates 5) (Channel 2)		
57	Avg (measuring rates 5) (Channel 3)		
58	Avg (measuring rates 5) (Channel 4)		
59	Avg (measuring rates 5) (Channel 5)		
	<b>Functions for E-channels (E1..5):</b>		
60	E2 - E3 (E-channel)		
61	E4 - E5 (E-channel)		
62	E2 - E4 (E-channel)		
63	E2 + E3 (E-channel)		
64	E4 + E5 (E-channel)		
65	E2 + E4 (E-channel)		
66	E2 • E3 (E-channel)		
67	E4 • E5 (E-channel)		
68	E2 • E4 (E-channel)		
69	E2 / E3 (E-channel)		
70	E4 / E5 (E-channel)		
71	E2 / E4 (E-channel)		
72	E2 / E2 % (E-channel)		
73	E4 / E5 % (E-channel)		
74	E2 / E4 % (E-channel)		
75	Channel 3 x E1		
76	$100 \times Ch1 / (Ch1+Ch2+Ch3+Ch4) \%$		
77	$100 \times Ch1 / (Ch1+Ch2+Ch3+Ch4+Ch5) \%$		
78	Ch1 f.ex E1=Ch1		
79	Ch2 E2=Ch1		
80	Ch3 E3=Ch1		
81	Ch4 E4=Ch1		
82	Ch5 E5=Ch1		
	All E channels have two alarm levels. You can set 10 extra alarms to one channel by using functions 78...82.,		
	Avg = Average value    % = ratio of channels		
	<b>If more numbers excits, they are for factory setting, pass them and continue programming.</b>		

# Typical applications

## Functions between channels

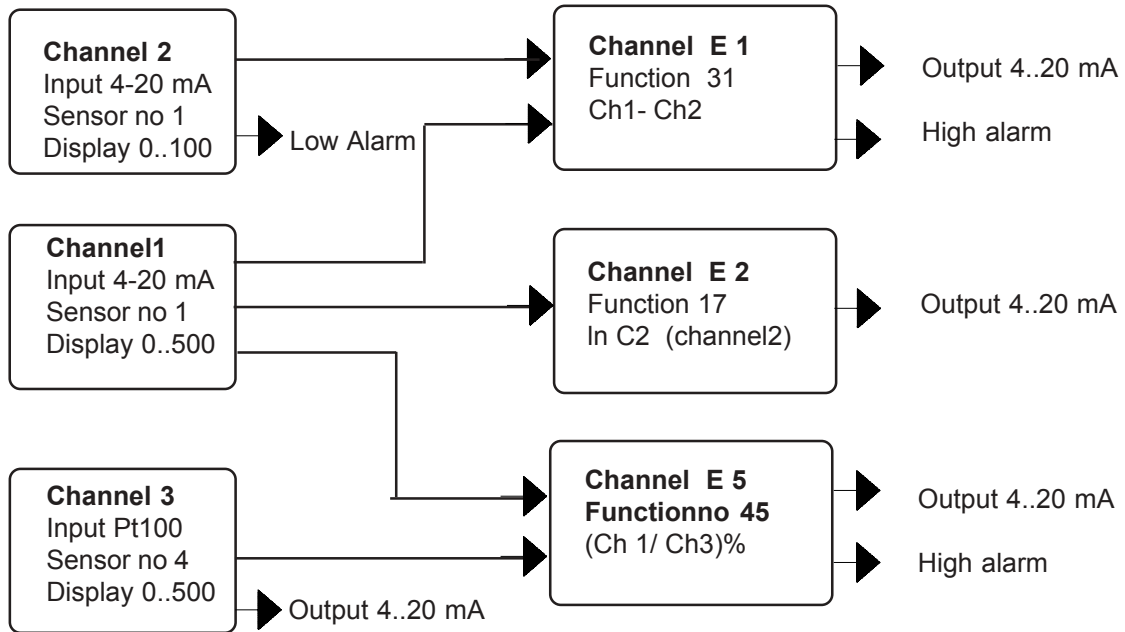

## 2...12 alarms to one channel

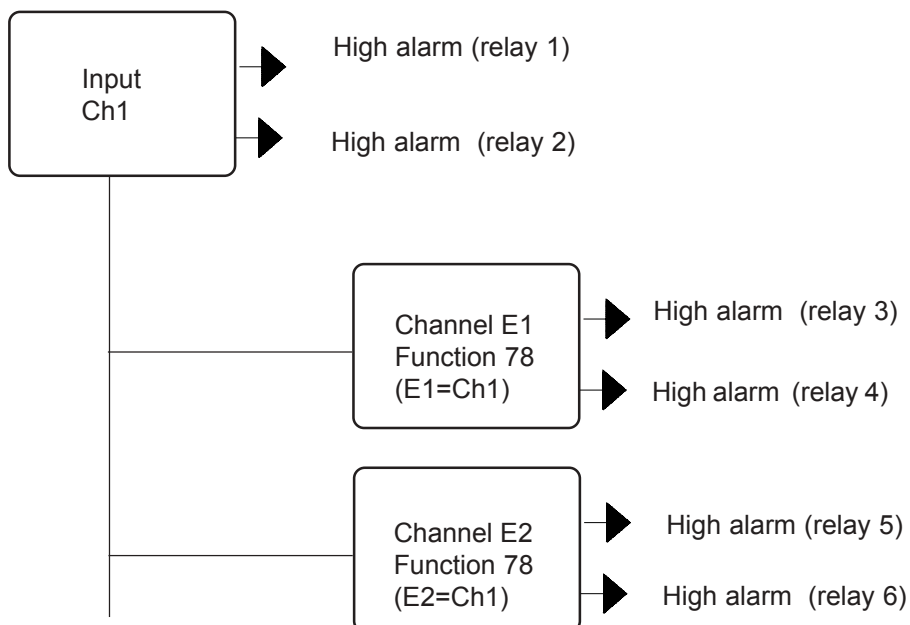

## Adding extra cards:

Output signals, logic alarms and second serial communication (RS232) needs extra card. Loose only the 3 screws and mount the desired card instead. The mounting of cards does not provide any calibration. The settings will be done only by front panel keys and 538 is ready for use.

## Procedure:

1. Remove electronics from the case. Loose fastening screws on the rear cover and remove the front panel.
2. Loose three screws as shown in picture. Remove flat cable.
3. Add the desired card to connector as shown in the picture. Mount output card to connector near to transformer and RS-card or logic card to the other connector.

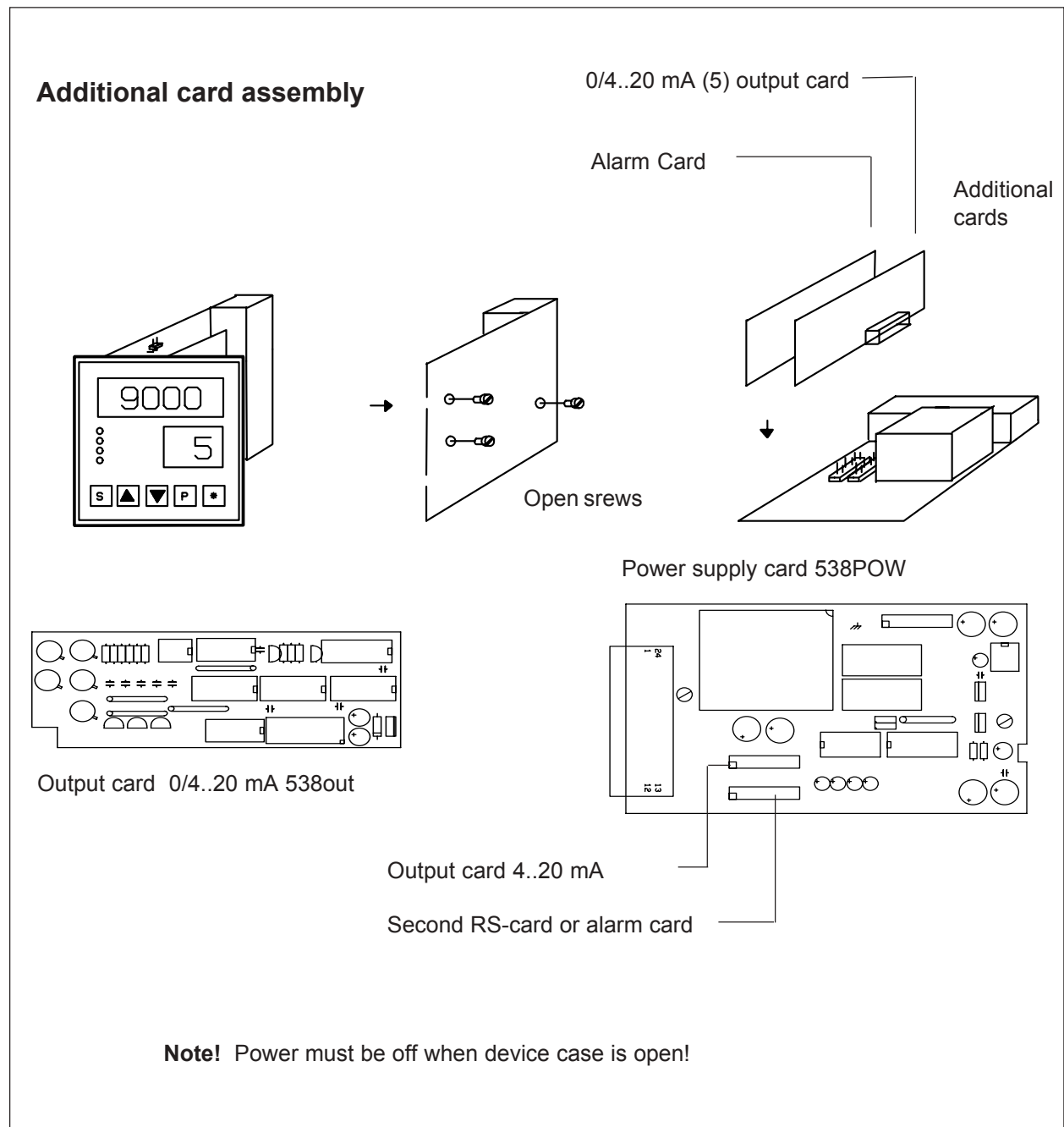

# Calibration:

## Model 538-5 (5 channels)

**Model 538 is an autocalibrating instrument and no conventional recalibration is necessary.**

However, if you change processor card or analog part, recalibration must be done.

### Reference values to be stored in memory:

Reference value shall be given to each measuring sensor. Accuracy of 538 is depending on the accuracy of this reference value.

### Reference values:

Voltage measurement 50.000 mV (channel no 1)  
Pt100 sensor 0.0 C (channel no 2)  
Thermocouple type K 20.0 C (channel no 3)  
Current input 20.00 mA (channel no 1..5)

You can now connect the sensors and set the given ref. values except current input. Place the jumper according to picture 1 and 538 is ready for calibration. Display shows text CAL. Choose sensors by arrow keys, CAL (50.000 mV), CUR (Pt100), SEN (20.00 mA), COLD (thermocouple), DAC (output signal 0..20.00 mA), **Voltage signal 50.000 mV must be calibrated first.**

You accept calibration by pressing \*-key, select the next one and continue until all calibrations has been made.

### Calibration procedure:

**1.** Remove electronics from case. Connect the sensors as shown in picture no 1. Let 538 to stabilize to room temperature, about 30 min, before calibration.

**2.** Connect jumper to connector L1. Display shows text CAL.

**3.** Feed 50.000 mV into channel 1. The accuracy of calibrator should be better than 0.01 % (5 1/2 digit). Press \*-key when display shows text CAL: Apply 50.000 mV to input and press \*-key, when you see 50 in the display. Apply 0.0 mV and press \*-key when

you see 0 in the display. The text CAL returns to the display when voltage calibration is done.

**4.** Connect Pt100-calibrator to channel 2 using 4-wire connection. Feed 0.0 C (100 ohm). Choose by \*-key text CUR. Press \*-key and display shows text CAL.

**5.** Connect TC-calibrator to channel 3. Use compensating cable type K. Feed 20.0 C to input. Choose by arrow-key text COLD. Press \*-key until display shows CAL. Calibrate before terminals are warm up (cold calibration). The display shows 1..2 C below or above real value during warm up time (about 1/2 hour).

**6.** Connect current signal 20.00 mA to channels 1..5 and close DIP-switches on the rear cover. Choose by arrow-keys text SEN and press \*-key. Display shows CAL.

**7.** Calibration of output signal. Connect DPM to output channel 1 (0..20 mA). Choose display to show DAC and press \*-key. Displays shows text LO. Press \*-key. Adjust by arrow-keys value 0.00 mA or 4.00 mA to output. Press \*-key and display shows text spa. Press \*-key. Adjust by arrow-keys value 20.00 mA to output.

All the points 1..7 may be repeated, if necessary. However, voltage calibration (50 mV) must be done first.

Calibration values will be saved in memory when you remove jumper from connector 1. Displays shows now text DONE. Display may be errorous during some seconds before new calibration coefficients correct values in the displays.

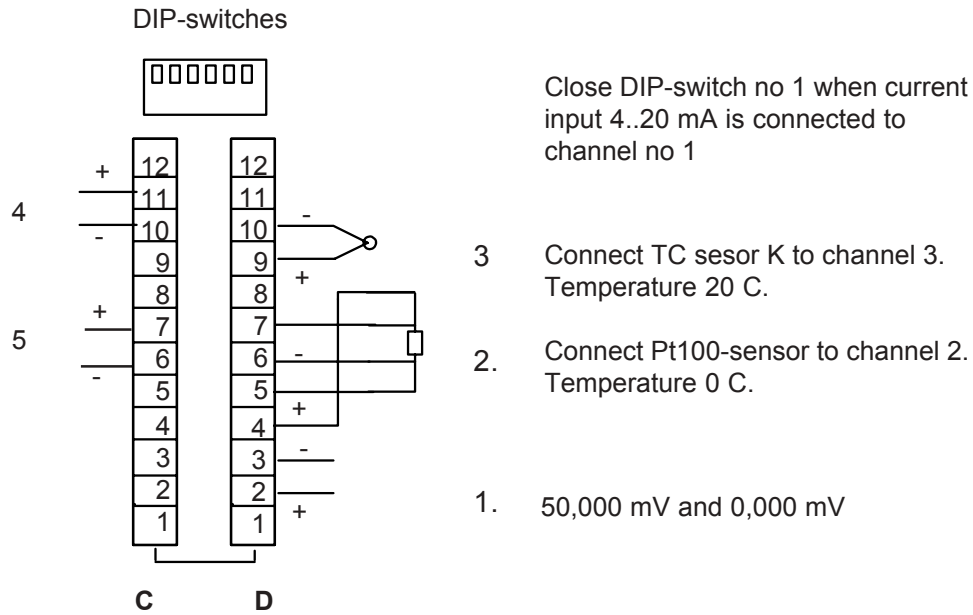

**Picture no 1. Connections and channels for calibration of mV, TC and Pt100 sensors (538-5)**

Put the jumper to connector L1 as shown in picture

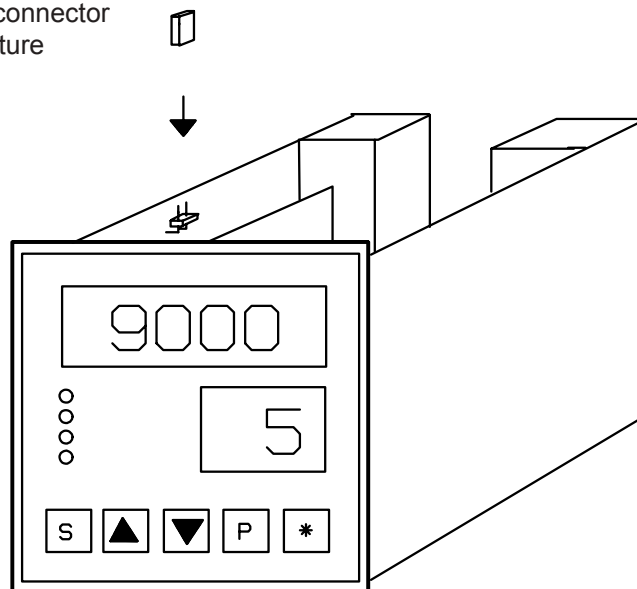

**Picture no 2. How to make 538 ready for calibration**

## Alarm Card 538REL

Relays 3 to 7 in  
Card 538REL/5

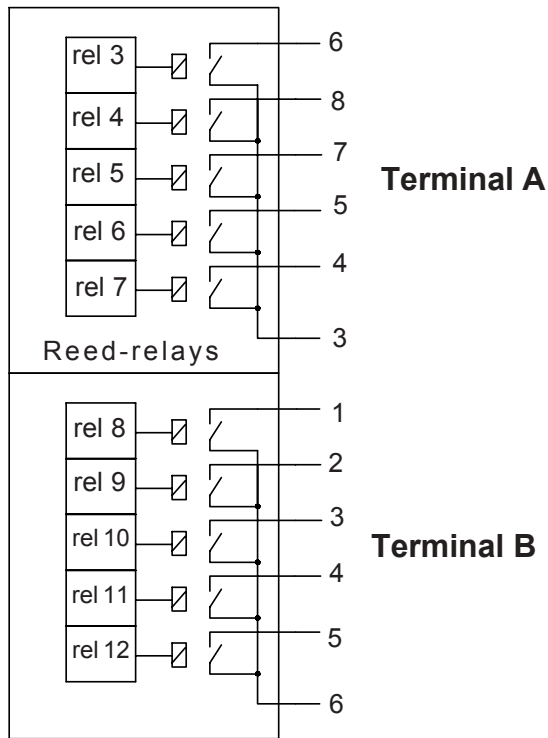

Relays: reed-relay, max 48 V, 0.5 ADC/AC.

Second serial output (for printer) can not be used, if expanded alarms used.  
Relays 8 to 12 in 538REL/10 board cannot be used simultaneously with output card 538OUT.

### Important Note

Because we continuously develop our products and add new functions, you may find on the display symbols not mentioned in the manual. This does not make any harm because you can simply pass those in configuration. The manuals will be, of course, updated at times.



## Ferrite core eliminates peaks from the power supply lines.

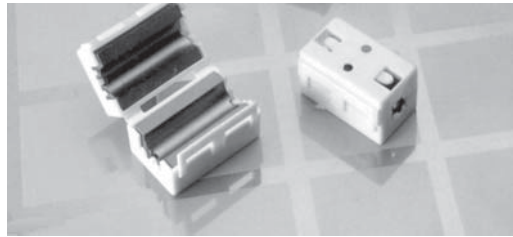

A range of easy to fit line filters provides a simple solution to the problems of radiated noise emissions generated by electronic equipment.

### Installing:

The filter is installed simply by clipping it around the power cable. Ferrite core is locked by compressing it tightly with no need to disconnect the cable or to remove connectors.

### Features:

- \* High performance EMC components dramatically reduces electromagnetic noise.
- \* High-performance ferrites with against high frequency noise.
- \* Easy installation for cable
- \* Can be added as first-aid, on -the-spot noise, when interferences occur.

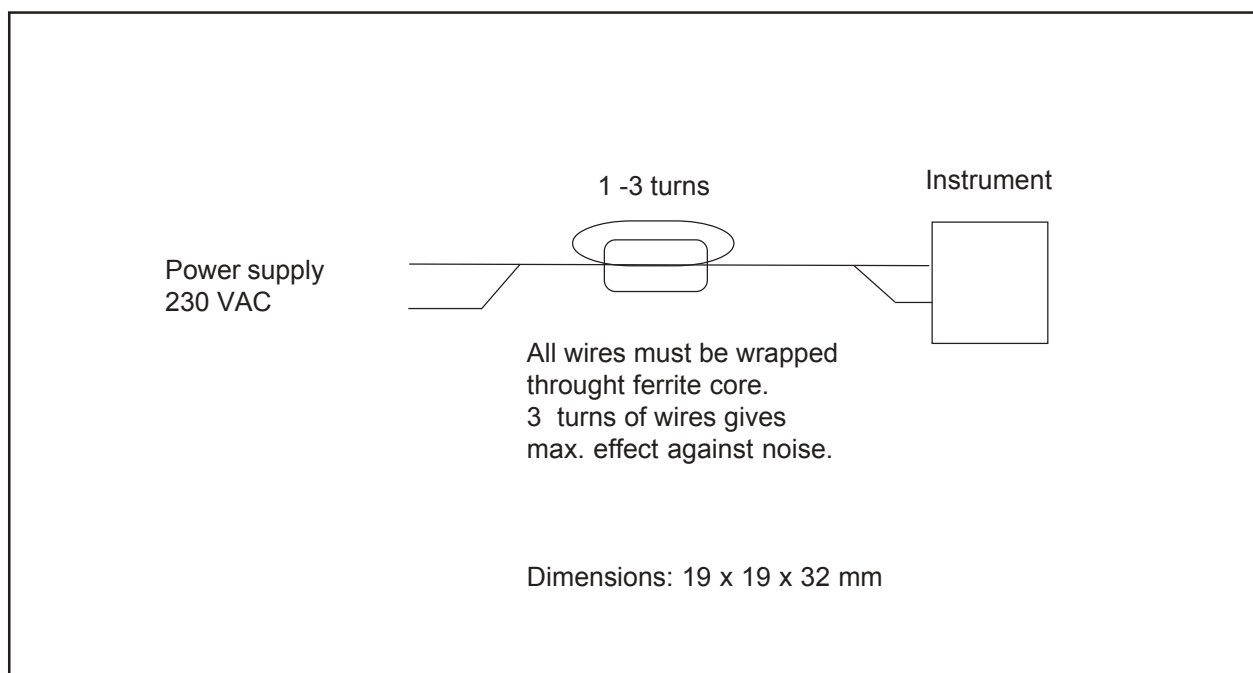

**Notes:**

**Notes:**

**Nokeval Oy**

Yrittäjäkatu 12  
FIN-37100 NOKIA  
FINLAND

Tel. +358 3-342 4800  
Fax. +358 3-342 2066