



POWERED BY
NOKEVAL



Flex-T
Flex-T-RH
Flex-CS
Flex-ES
Flex-nSens
Modular wireless
transmitters

Manual

Contents

Introduction	2
Warnings.....	2
Trademarks	2
Manufacturer.....	3
Modules and models.....	4
Installation	6
Configuration	7
Flex-T and Flex-T-RH modules.....	8
Flex-CS and Flex-ES modules	9
Flex-nSens module.....	10
FT10-RT433 radio module.....	11
Flex-Zone-Radio module	12
Flex-Sky-Radio module.....	14
Maintenance.....	16
Troubleshooting.....	17
Specifications	18
Declaration of conformity.....	20

Introduction

The Nokeval Flex is a series of wireless transmitters for temperature, humidity and other quantities. There are several models, each optimized for a different task as detailed below. A variety of different radio modules can be used.

Warnings



The device and its battery must not be disposed of in household waste. Observe local regulations concerning the disposal of electrical waste.

Trademarks

LoRa is a trademark of Semtech Corporation. LoRaWAN is a trademark of LoRa Alliance. Wirepas is a trademark of Wirepas Oy.

Manufacturer

Nokeval Oy
Rounionkatu 107
FI-37150 Nokia
Finland

Phone +358 3 342 4800 (Mon-Fri 8:30-16:00 EET)
WWW <http://www.nokeval.com/>
Email support@nokeval.com







Modules and models



Each Flex series transmitter consists of two detachable parts or halves: a measurement (or bottom) module, and a radio (or top) module. The measurement module contains the input, the microcontroller, the calibration data (except for the nSens probe which holds the data of its own), and the battery. The halves can be ordered separately or together.



The current measurement modules available have been listed below. The pictures include the Ovazone radio module.

Flex-T	Measures the ambient temperature with a built-in Pt100 sensor. More on page 8.	
Flex-T-RH	Measures the ambient temperature with a built-in Pt100 sensor plus the ambient relative humidity with a polymer sensor. Page 8.	
Flex-CS	Measures temperature with an external Pt100 sensor connected via an M12 connector (supplied). The sensor is not supplied, but any 4-wire Pt100 can be used. Page 9.	
Flex-ES	Measures temperature with an external Pt100 sensor connected to a spring loaded connector inside the transmitter. The sensor is not supplied, but any 4-wire Pt100 can be used. Page 9.	
Flex-nSens	Measures temperature and humidity using a Novasina nSens probe. The probe is not included. Page 10.	

The available radio modules are:

FT10-RT433	Radio transmitter for Nokeval’s 433 MHz “MTR series”. The combined product is named Flex-RT433-T for example. Details on page 11.	
Ovazone-Flex-Radio or Flex-Zone-Radio	Radio transceiver for 2.4 GHz mesh known as “Ovanet”, “Ovazone”, or “Zone”. The combined product is Flex-Zone-T for example. (Previous naming was Ovazone-Flex-T.) Page 12.	
Flex-Sky-Radio	Radio transmitter for Sky 433 MHz LoRa system (also known as “Ovasky”). The combined product is Flex-Sky-T for example. Page 14.	

The wireless settings are stored and retained in the radio module. Exchanging the measurement module does not affect them, which allows easily exchanging the measurement module to a recalibrated unit, especially with the T and T-RH models. Also some of the other settings are stored in the radio module, e.g. the measurement intervals.

To detach the two modules, first grasp the measuring module on its locking latches and fully depress them to release the latches. Then pull the measuring module straight out of the radio module. You may need to wiggle the measuring module slightly to more easily overcome the friction caused by the two O-rings. If necessary, support the radio module by holding it in place with your other hand at the same time when pulling out the measuring module.

To join them, align the small embossed arrowheads on both modules' housings (when they are aligned, also the silver colored labels on both modules are on the same side). Then push the measuring module straight into the radio module until the locking latches catch and click into place.

This manual has a chapter for each measurement and radio module. Refer to the modules suitable for your module types.

Installation

Opening the measurement module

Opening the module is necessary only for replacing the battery and for wiring the internal connector on the ES model.

- Detach the measurement module from the radio module.
- Use a large flat-bladed screwdriver to push the measurement module cover off via the rectangular hole (see picture).
- Pull the circuit board out.
- Assemble reversely, taking care that the circuit board sits on the grooves.

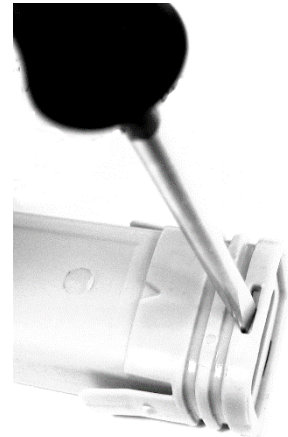

Wiring

The wiring of the sensor connector is described in the chapter for each module, where applicable.

Configuring

Configure the device per page 7 and per the chapters for your modules.

Mounting

Select a good place for the transmitter, avoiding metal surfaces near the radio module.

Fasten the radio module to a surface either with a double-sided tape or with two screws 50 mm apart. The maximum diameter of the screws is 4.5 mm.

Alternatively, use a mounting plate available separately.

If not already, join the two modules.

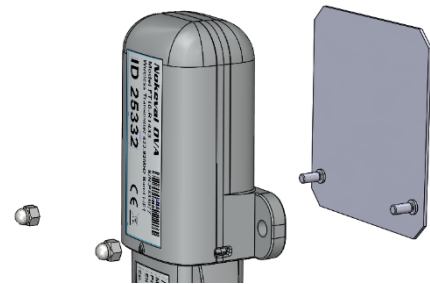

Using with Oviport

The device sends the measurement data with its radio network address using the channels as described in the measurement module chapters. A compatible gateway is needed.

Configuration

Configuration means adjusting the settings like the measurement interval, the wireless network settings, or the measurement settings. To view and change them:

1. If the measurement module was not recently connected to a radio module, connect it for a couple of seconds (until the LED inside shines). A part of the settings is stored in the radio module, namely the ones shaded in orange in the picture below. Now the measurement module can read the settings to its memory. The purpose of storing some settings in the radio module is to allow replacing the measurement module with a fresh recalibrated unit, still using the settings optimized for the local application.
2. Detach the modules.
3. Connect a Nokeval DCS772 programming cable to the 3.5 mm jack in the measurement module.
4. Launch the Nokeval Mekuwin software (freely downloadable from <http://www.nokeval.com/>). Select your DCS772 from the list, then select Protocol=SCL, Baud=9600, Address=0, and click Direct. A new window should open, showing the settings as a tree.
5. Adjust the settings, and finally click Save to EEPROM. The settings that are stored in the measurement module are now written to the non-volatile EEPROM memory. In addition, the settings that are to be stored in the radio module, are temporarily stored in the measurement module, and a flag is set to write the settings to their final location.
6. (If there is no menu visible but a text “Connect radio for a moment”, something went wrong. Repeat from step 1.)
7. Close the Mekuwin connection.
8. Disconnect the 3.5 mm plug.
9. Join the modules. Now that the flag is set, the settings are written to the radio module EEPROM.

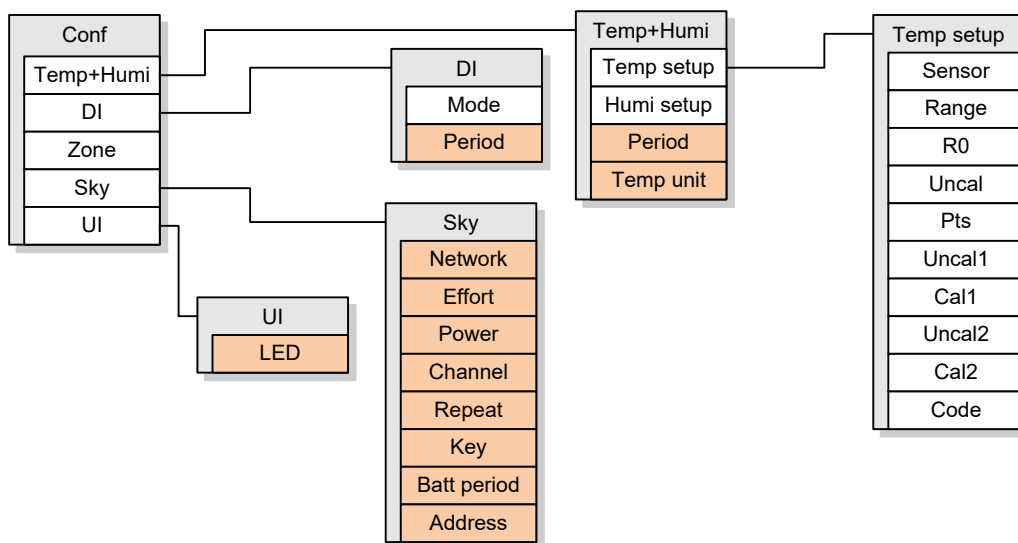

The exact contents of the menu depend on the module types. Some general guidelines:

- The **Temp+Humi** and **Inputs** menus contain sensor input related settings. See the relevant measurement module chapter in this manual.
- The **Zone** and **Sky** menus contain radio related settings. See the radio module chapters in this manual.
- The **UI** menu contains one setting: whether to blink the indicator **LED** light or not. It is recommended to keep the light on as it will help in troubleshooting. It can be turned off for maximal battery savings or for a discreet operation.

Flex-T and Flex-T-RH modules

Wiring

The T and T-RH modules have no external connections as they measure the ambient air. The temperature sensor is located inside the enclosure, at the bottom end. The humidity sensor is inside a protruding sintered filter.

Temp+Humi configuration menu

Temp setup and Humi setup submenus: These are for selecting the temperature sensor type and for tuning the reading. For the -T and -T-RH models, these menus contain the factory calibration (fine tuning) and should not be accessed unless recalibrating the transmitter. If the values are to be adjusted, refer to the CS and ES model menu on page 9, it is similar. Please note that if the *Sensor* setting in the Temp setup menu is set to *Humi*, then the temperature reading is obtained from the humidity sensor instead of the internal RTD. When the temperature (and humidity) have been factory calibrated, the corresponding submenu will be password protected to prevent further adjustment.

Period: Select the temperature measurement interval in seconds. 60...300 seconds is a good range for most tasks. An unnecessarily short interval will consume the battery and the radio band.

Temp unit: Select the temperature unit °C or °F.

Output

The radio sends the measurement data using the channels as follows:

Channel	Physical quantity	Unit
1	Temperature	°C or °F
2	Relative humidity (T-RH only)	%RH
3	Battery status (not with FT10 radio)	%
4	Neighbors (not with FT10 radio)	pcs

Flex-CS and Flex-ES modules

Wiring

In the CS model, the RTD sensor is connected to the M12 connector. The module has a female connector. A compatible male plug with screw terminals is supplied. The plug has small terminal numbers. A 4-wire sensor should be used, connect its one end to terminals 1 and 2, and the other end to 3 and 4.

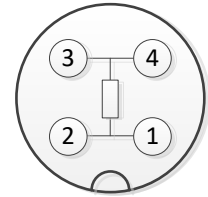

The ES model has spring loaded connector block inside the enclosure. Open the enclosure as described on page 6. Bring the cable inside the enclosure through the cable gland and connect the sensor wires to the grey-orange block. Push down the orange buttons if necessary to aid inserting the wires. Then you can choose to tighten the gland or tighten it later. Insert the circuit board back in the enclosure, guiding the cable and wires. Replace the cover.

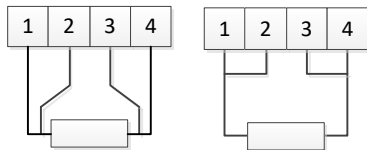

If a 2-wire sensor is used, connect it to 1 and 3 and loop 1 to 2 and 3 to 4, but be prepared for a significant measurement error due to the cable resistance.

Temp+Humi configuration menu

For the -CS and -ES models, the *Temp setup* menu provides the following settings for setting up the sensor:

- **Sensor:** Select Pt, Ni, or Cu according to the sensor type.
- **Range:** Select the appropriate range depending on the temperatures to be measured. A smaller range gives better resolution. The Low range can be used up to 120 ohms (50 °C with a Pt100). The Mid range can be used up to 240 ohms (380 °C). The High range can be used up to 500 ohms. The Max range can be used up to 2000 ohms (250 °C with a Pt1000).
- **R0:** Enter the nominal resistance of the sensor. With a Pt100, it will be 100. With a Pt1000, it will be 1000. If the precise resistance of the sensor is known, e.g. stamped on the sensor, enter it here to remove the sensor error.
- It is possible to adjust the reading in one or two points if desired. If this is not necessary, set **Pts**=0. To adjust in one point, i.e. to use offset correction, set **Pts**=1, enter the uncorrected reading in **Uncal1** and the desired (reference device) reading in **Cal1**. For a two-point adjustment, set **Pts**=2 and use **Uncal1-2** and **Cal1-2** to get two points adjusted.
- **Code:** Allows password protecting this menu.

Period: Select the temperature measurement interval in seconds. 60...300 seconds is a good range for most tasks. A short period will consume the battery and the radio band.

Temp unit: Select the temperature unit °C or °F.

Output

The radio sends the measurement data using the channels as follows:

Channel	Physical quantity	Unit
1	Temperature	°C or °F
3	Battery status (not with FT10 radio)	%
4	Neighbors (not with FT10 radio)	pcs

Flex-nSens module

Sensor probe

The measurement module accepts a Novasina nSens-HT-ENS or an nSens-HT-CSS humidity and temperature probe. For that, the measurement module has a three-pole female connector. The Novasina probe can be attached directly to the measurement module, or an up to 2 m extension cable used in between.

The Novasina probe must have a firmware 2.00 or newer. Otherwise it will not work at all. It is beneficial to have a Novasina hardware version 2.00 or newer, otherwise the current consumption will be much greater.

The probe contains the calibration data of its own. Replacing the probe with a recalibrated one will restore the accuracy. Please still consider replacing the battery too. To adjust the Novasina calibration, use tools provided by Novasina, the details falling outside the scope of this manual.

Temp+Humi configuration menu

Temp setup and Humi setup submenus: These are for selecting the temperature sensor type and for tuning the reading. As the Novasina probe is very accurate and has calibration options of its own (via Novasina's tools), it is not recommended to adjust the readings here. Both the Pts settings should have a value of 0 meaning no adjustment.

Period: Select the temperature measurement interval in seconds. 60...300 seconds is a good range for most tasks. A short interval will consume the battery and the radio band.

Temp unit: Select the temperature unit °C or °F.

Output

The radio sends the measurement data using the channels as follows:

Channel	Physical quantity	Unit
1	Temperature	°C or °F
2	Relative humidity	%RH
3	Battery status (not with FT10 radio)	%
4	Neighbors (not with FT10 radio)	pcs

FT10-RT433 radio module

The FT10-RT433 radio module has been originally designed for the FT10 series (e.g. FT10-RT433-IS transmitter) but it can be used in the Flex series too (since firmware 2.0). It allows using the Flex measurement modules with the Nokeval MTR wireless series devices, e.g. the RTR970 receiver, the FT20-RTC433-RECEIVER, and Ovazone-Wave-Link-MTR gateway.

About the MTR series

The MTR series uses simple unidirectional transmissions on 433.92 MHz frequency at less than 10 dBm power. The transmitters transmit at a predetermined interval with no listen-before talk and with no acknowledging. Consequently it is very normal that some packets are lost due to collisions with the other MTR transmitters, other users of the 433 MHz band, or just due to noise.

The MTR system is extremely simple to set up. There are no network addresses, no encryption. Just configure the transmitter interval and place one or more receivers within the range. There can be multiple receivers, they will each try to pick the transmission, not interfering with each other.

The range may exceed 1000 m outdoors with a line of sight. A typical indoors range is 30 to 100 m.

Before using the 433 MHz radio, make sure it is legal in your country.

The antenna is typically mounted directly on the radio module, but it is also possible to use an extension cable. The supplied antenna should be used. Using any directional antenna is illegal. The gain must not exceed 2.5 dBi.

Configuration menu

There is nothing to configure for the radio, thus no menu.

Output

Each FT10-RT433 module has a radio ID (or address) marked on its label. However as the MTR series data format does not allow multiple channels on an ID, the Flex series uses multiple ID's for its channels. Each channel uses an ID increased by 1000. For example if the radio has labelled an ID of 27120, the first channel is transmitted on ID 27120, the next 28120, the next 29120, etc. The offset is not one because a single user typically has consecutive ID's which would then collide.

Flex-Zone-Radio module

Attaching an Ovazone or Zone radio to any of the Flex measurement modules makes it compatible with the Nokeval Zone/Ovazone/Ovanet radio network.

About the wireless technology

Ovanet is Nokeval's second generation radio network. It uses Wirepas Connectivity technology and Nokeval's own additions. It utilizes the 2.4-2.48 GHz band, which is available all over the world. The product names basically begin with the Ovazone prefix.

Every device in the network, also the battery powered ones, will function as a repeater by assisting devices located far away from the gateway, effectively forming a mesh network.

The network has several node devices producing measurement data, and one or more gateways. The gateway connects the wireless network to the other systems. Examples of the gateway devices are the Wave-Link and the Cell-Link. They are used to deliver the data of the radio network to the Ovanet web service.

Each device, including the nodes and gateways, must be set to the same Ovanet network. The Ovanet network number must be chosen between 1-16777214. It should be generated with a random number generator, to minimize the probability to accidentally choose the same network number with another network located nearby. By default, the devices are set to the network number 6829663, which can be used if there are no other Ovanet or Wirepas Connectivity networks within a couple of hundred meters. If two networks have the same number by accident, the node devices may connect to a wrong network and the data is not delivered to the desired gateway.

Each device has a unique Ovanet address. It is set at the factory and there is no need to change it. The address is visible in the label of the radio module.

The devices automatically change their radio frequency seeking suitable frequencies in the crowded 2.4 GHz band. However, at power-up the devices need to find other devices in the network, for which a common radio frequency is needed. All the devices of the network need to be set to the same radio channel between 1-27. Usually the default channel 1 is ok.

There is no need to configure any other radio network settings. The network searches automatically for the best connections and updates them if needed.

The open space range between the nodes is about 200 meters and indoor range is typically 10 to 30 m depending on the construction materials. Avoid placing the devices near a metal surface as it will decrease the range.

The Flex transmitters have a buffer memory to store the readings when the wireless network is not able to deliver the data to a gateway. The buffer can hold approx. 300 measurements. When the buffer reaches 50 %, the measurement interval of all the channels will be increased temporarily, the more the fuller the buffer is. When the wireless network works again, the data will be delivered. If the radio module is detached, the buffer will be cleared.

Zone configuration menu

The Zone (or Ovanet in older versions) menu contains the settings for the wireless network. After changing the settings, close the Mekuwin session, disconnect the programming cable and attach the radio module. Wait until the indicator in the measurement module lights for a moment. The configured settings will be loaded to the radio module on the first attachment but not on the subsequent attachments unless they are changed again.

Furthermore, if another radio module is connected to the measurement module, the measurement module will read the wireless settings to its memory so that they are visible in the configuration menu on the next Mekuwin session.

Network: This setting determines the Ovanet network address. It must be the same on all the radio devices including the gateway device. Default 6829663.

Channel: This setting determines the Ovanet network channel. It must be the same on all the radio devices including the gateway device. Default 1.

Cipher and Auth: If you want an encrypted radio network, enter two keys. Every device in the network must share the same keys. The key can be any text string (a Fowler-Noll-Vo hash will be generated of it) or a 128-bit hexadecimal value beginning with 0x. Default empty.

Relay: Defines if this device participates in relaying (repeating) the packets of the other devices. Normally this should be on to ensure the operation of the mesh network. For maximal battery savings this can in some situations be switched off.

Remote conf: This setting defines if this device accepts configuration commands from the radio network. It is advisable to switch this off when no encryption is used.

Battery period: If set to non-zero value, this transmitter will transmit its battery status and number of network neighbors similarly to the measurement readings at the interval defined by this setting in seconds. Please note that the battery status value is very coarse as explained on the page 16.

Node address: This shows the unique address of the radio module, same as in the label. The node address cannot be changed here. If a radio module hasn't been attached yet, this will be 0.

Neighbors: This shows how many other devices this device has been networked with.

Buffer: This shows how many percent of the measurement buffer has been used. Normally this will be 0, but if the radio network doesn't work, then this device will store the measurement readings in its buffer. When the buffer is more than 50% full, the measurements will be slowed down.

Flex-Sky-Radio module

By equipping any of the Flex measurement module with an Flex-Sky-Radio module, it can be used with the other Sky devices, e.g. the Flex-Sky-Link-RS485 receiver. The measurement module must have a firmware 2.1 or newer.

About Sky

The Sky devices use the Semtech LoRa modulation technique that allows unforeseen wireless range in a battery powered transmitter. The protocol used is defined by Nokeval, called NLORA1, which means that the Sky devices are not compatible with the LoRaWAN infrastructure.

The modulation has some parameters to define its operation. With “maximal” settings, a very long range can be reached, but at the expense of high battery and radio band consumption. One radio transmission can last approx. 2 seconds (compared to 20 ms of the MTR series). This means that the number of transmitters within the range must be limited in order to avoid collisions and to allow radio time for each. It is not practical to use a short interval between transmissions; 10 to 30 minutes is the recommended interval range.

When the maximal range is not necessary, the parameters must be adjusted for lower battery and band consumption. All the devices within one network must share the parameters, because the receiver can only listen with one set of parameters at a time. Consequently the parameters must be selected according to the most distant device. It is also possible to adjust the transmission power. The devices that are closer to the receiver can use a lower power setting.

Before using the 433 MHz radio, make sure it is legal in your country.

The antenna is typically mounted directly on the radio module, but it is also possible to use an extension cable. The supplied antenna should be used. Using any directional antenna is illegal. The gain must not exceed 2.5 dBi.

Sky configuration menu

The Sky menu contains the settings for the wireless network. After changing the settings, close the Mekuwin session, disconnect the programming cable and attach the radio module. Wait until the indicator in the measurement module lights for a moment. The configured settings will be loaded to the radio module on the first attachment but not on the subsequent attachments unless they are changed again.

Furthermore, if another radio module is connected to the measurement module, the measurement module will read the wireless settings to its memory so that they are visible in the configuration menu on the next Mekuwin session.

Network: To prevent mixing the different networks (and users) data, the network address should be set to some value not used nearby. In most cases a random value 1 to 255 is OK. All the devices within one network must share the value. The receiver will only accept packets that have the matching network address. Default 1.

Effort: The modulation effort. The bigger value, the longer range but the more battery and radio band consumption. This single setting controls the LoRa bandwidth and spreading parameters as in the table below. Increasing the effort one step will coarsely add 2.5 dB in the link budget, or 30% of open-space range, but also double the battery consumption caused by the radio.

The range estimates are only estimates, the real range depends heavily on objects on the radio path. Especially metal walls will severely attenuate radio waves.

Effort setting	Bandwidth	Spreading factor	Estimated indoor range 40...35 dB/decade	Estimated outdoor range 30 dB/decade
1	250 kHz	7	110...310 m	1300 m
2	250 kHz	8	120...370 m	1600 m
3	250 kHz	9	140...440 m	2000 m
4	250 kHz	10	160...520 m	2400 m
5	250 kHz	11	190...610 m	2900 m
6	250 kHz	12	220...720 m	3500 m
7	125 kHz	12	260...870 m	4400 m

The default Effort is 4, which is good for many tasks.

The Effort setting can be set to Custom position; then it is possible to set the bandwidth and spreading parameters independently, as well as adjust the frequency steplessly within 433.3 to 434.5 MHz. Normally this should not be necessary.

Power: The transmission power; 10 means the maximum power (the value is approximately in dBm). A lower value should be selected to conserve battery and to avoid disturbing other users of the band whenever possible. However this setting will not affect the battery consumption as much as the Effort setting, which means that the first mean to lower the battery consumption should be lowering the effort if possible.

Channel: The radio frequency channel. If several LoRa/Sky networks exists within the same area, a different frequency should be selected for each network. The radio frequency is $433.3 + 0.2 \text{ MHz} \cdot (\text{channel}-1)$, i.e. the first channel is 433.3 MHz, second 433.5 etc. When using bandwidth of 250 kHz, the nearby networks (systems) should have channels of at least two steps apart, e.g. 1 and 3 to avoid overlap. The channel 4 uses 433.9 MHz which is the most crowded frequency on this band, so it should be avoided.

Key: An authentication and encryption key for the radio. If an authentication is not desired, leave this blank. Then it is quite easy to eavesdrop and disrupt the radio traffic. To get a secured operation, enter any text string (up to 16 characters). Use the same key in the receiver, and consequently in all the other transmitters.

Acknowledge: Defines if the transmitter requests an acknowledge from the receiver, and retransmits when the acknowledge fails. This increases reliability but consumes more current. Use this when a regular throughput is desired. Do not use if it is ok to lose some packets now and then. This feature is not available yet.

Destination: Available only when acknowledgement is used. This is the address of the receiver that is supposed to acknowledge. The network may have several receivers, and it is not desirable that all of them acknowledge.

Repeat: How many times a radio packet is transmitted. Normally this should be 1, but it is possible to repeat each packet for increased reliability, at the cost of battery consumption.

Battery period: If set to non-zero value, this transmitter will transmit its battery status and number of network neighbors similarly to the measurement readings. Please note that the battery status value is very coarse as explained on the page 16.

Address: The address of the last connected radio module. Can't be changed here.

Maintenance

Battery

When the battery is about to die (reported state below 20%), replace it:

- Open the measurement module as described on page 6.
- Replace the battery with a new battery, according to the type marked on the circuit board. Note the polarity as marked on the circuit board.
- Assemble the device.
- Properly dispose of the used battery observing the local regulations.

Recalibration

It is recommended to recalibrate the measurement module every two years. Detach the measurement module and send it for recalibration. Alternatively obtain a recalibrated module, exchange it to the radio module, and send the old module for recalibration. Normally the recalibration includes replacing the battery.

The calibration certificate for the measurement module can be downloaded from www.nokeval.com.

The nSens model is an exception. As the calibration data is stored in the nSens probe, it is sufficient to recalibrate the probe only. However for replacing the battery, it may be convenient to send the measurement module to be serviced too.

Cleaning

The enclosure exterior can be wiped with a damp cloth soaked in soapy water or isopropyl alcohol, except that it is not allowed to wipe the humidity probes of the -T-RH and -nSens models. The filters of the humidity probes can be manually screwed off, cleaned, dried, and reattached.

Storage

If the device is not used for a while, detach the modules to stop the measurements and radio transmissions and store the halves in a dry place. For longer storage, remove the battery.

Troubleshooting

If there is a suspicion of the proper operation, first check the indicator light. It blinks every 30 seconds through the bottom right side of the enclosure, unless it has been disabled in the configuration menu.

- One blink: everything OK.
- Two blinks: Battery low, please replace soon (page 16).
- Three blinks: Radio error. Try reconfiguring the radio parameters. If it doesn't help, send the device for service.
- Four blinks: Network error. No connection to a gateway. Check that the gateway is operating. Check that the distance to the gateway or Zone neighbor devices is not too long. Check that the radio settings correspond to the other devices in the network.
- Five blinks: Humidity probe error. For nSens model, make sure a sensor has been connected, and it has a firmware 2.00 or newer. Send the device for service.
- Six blinks: A/D converter error. Send the device for service.
- Seven blinks: Pt100 error; internal Pt100 in the -T model, external in the -CS and -ES models. Check the external sensor.
- Eight blinks: Configuration settings not available. Re-configure the settings.
- Nine blinks: Factory calibration data not available. Send the device for service.
- Not blinking at all: Make sure you have the two modules connected – the indicator will not blink when separated. Check the battery (page 16) with a multimeter, it should have 3.3 to 3.7 V. If in doubt, replace it anyway. Please note that it is possible to turn the indicator off in the settings.
- Irregular or very fast blinking: Battery too low for operation.

If the measurement reading is incorrect, check the sensor and its connections. If it didn't help, connect to the device with the programming cable and Mekuwin as described on the page 6. Check all the settings, and use the Mon(itor) menu to check the readings.

If there are problems connecting with the programming cable, check that the indicator light is constantly on when the cable is plugged in the jack. If not, replace the battery and try again.

Specifications

Environment

Storage temperature	-40...+60 °C
Operation temperature	-30...+60 °C
Operation humidity	0...100 %RH
Protection class	IP 65
Enclosure material	Plastic (PC+ABS)

Dimensions

Dimensions for Flex-Sky-T:

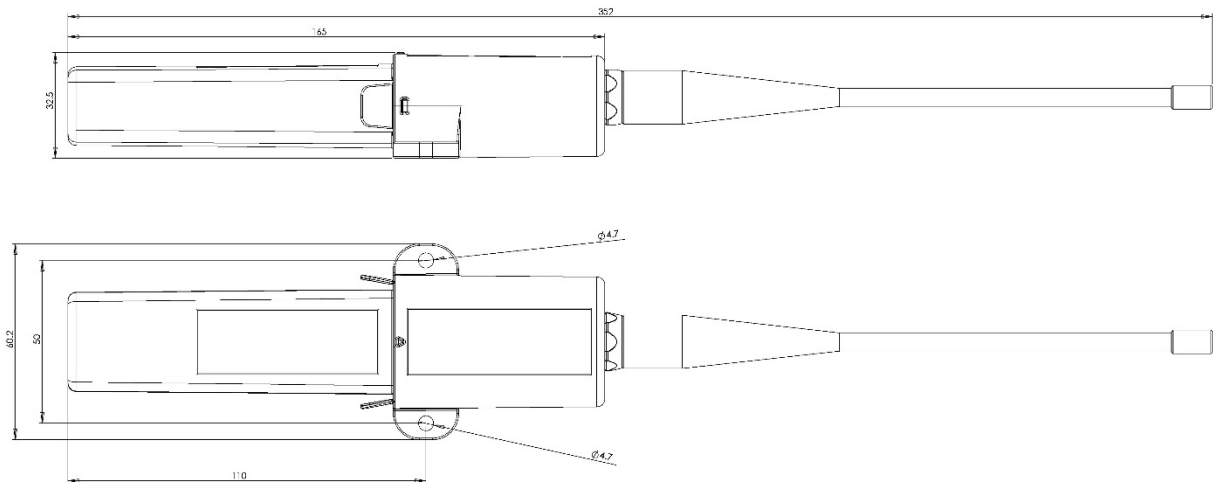

FT10 radio	The same dimensions.
Zone/Ovazone radio	No external antenna; add 5 mm to the body (165+5 = 170).
ES models	Add 20 mm to bottom for a cable gland.
CS models	Add 85 mm to bottom for a connector.
RHT models	Add 38 mm to bottom for a probe.
nSens models	Add 118 mm to bottom for a nSens probe.
Weight	Measurement module: T 62 g, RHT 82 g, ES 70 g, CS 84 g (without M12), nSens 77 g (without probe) Radio module: RT433 80 g (with antenna), Ovazone 34 g, Sky 81 g (with antenna)

Internal battery

Type	LR6 1.5 V alkaline AA size battery, e.g. Energizer EN91.
Battery life	1-5 years depending on the model and the measurement interval and the radio network traffic amount. Typically, 1-2 years with Ovazone radio, and 2-5 years with the other radios if the measurement interval is not too dense.

FT10-RT433 radio

Antenna	Dedicated ¼ wave whip with a BNC connector, Laird EXC420BNX or similar, max gain 2.5 dBi
Center frequency	433.92 MHz
Bandwidth	max 550 kHz OBW
Transmitting power	max 10 dBm E.I.R.P.
Open space range	about 1000 m
Indoor range	30 to 100 m typically
Buffer memory	No buffering.

Zone/Ovazone radio

Antenna	Internal antenna
Frequency	2.400-2.483 GHz worldwide license-free ISM band
Transmitting power	max 5 dBm E.R.P.
Open space range	about 200 m

Indoor range 10 to 30 m typically
Buffer memory 300 packets, corresponding to about 10 h with the default interval.

Sky radio

Antenna Dedicated ¼ wave whip with a BNC connector, Laird EXC420BNX or similar
Center frequency 433.3...434.5 MHz user adjustable
Bandwidth max 300 kHz OBW
Transmitting power max 10 dBm E.I.R.P.
Open space range about 10 km with maximal parameters
Indoor range 150 to 500 m typically

T model

Sensor type Internal Pt100 element
Measurement range -30...+60 °C
Accuracy ±0,5 °C in the range of -30...+50 °C
Step response time max 40 min to 90% (1 m/s flow)

T-RH model

Temperature sensor type Internal Pt100
Temperature range -30...+60 °C
Temperature accuracy ±0,5 °C in the range of -30...+50 °C
Temperature step resp. max 40 min to 90%
Humidity sensor type Capacitive polymer humidity sensor inside a sintered filter
Humidity range 0...100 %RH
Total error band ±5 %RH over 10...90 %RH and +5...+50 °C
Typical accuracy ±3 %RH over +0...+50 °C

ES and CS models

Sensor type External 4-wire Pt100 (or Ni100 or Pt1000) sensor, not supplied
Cable length <30 m
Measurement range Pt100: -200...+650 °C
Accuracy 0.05% rdg + 0.2 °C at 25 °C ambient
Thermal drift 0.01 °C/°C

nSens model

Sensor type Novasina nSens-HT-ENS or nSens-HT-CSS, not supplied
Cable length max 2 m
Measurement range See Novasina's documentation; max temperature 60 °C for the meas.module
Accuracy See Novasina's documentation

Conformity

Directives See DoC on next page
Standards See DoC on next page

Declaration of conformity

Nokeval
made to measure

EU Declaration of Conformity

Object of declaration: Wireless measuring device
Model/Type: Flex-Sky-T/ES/CS/RHT/nSens
Flex-RT433-T/ES/CS/RHT/nSens
Description: Wireless 433.92MHz temperature and humidity transmitter. Sky based on LoRa-modulation. RT433 based on OOK-modulation.
Manufacturer: Nokeval Oy
Rounionkatu 107, 37150 Nokia, Finland

www.nokeval.com
tel. +358 33424 800
support@nokeval.com

This declaration of conformity is issued under the sole responsibility of the manufacturer.

The object of the declaration described above is in conformity with the relevant Union harmonization legislation:

Directive (RED) 2014/53/EU
Directive (RoHS) 2011/65/EU

The conformity is given based on the following harmonized standards:

RED: EN 300 220-2 V3.1.1 (2017-02)
EN 301 489-1 V2.1.1 (2017-02)
EN 301 489-3 V2.1.1 (2017-03)
EMC: EN 61326-1:2013
LVD: EN 61010-1:2010
RoHS: EN 50581:2012

Product is marked with CE mark to indicate compliance.
Product is designed and manufactured in Finland.

Signed for and on behalf of Nokeval Oy:

At Nokia 17.1.2017



Jani Vähäsöyrinki, Managing Director

www.nokeval.com